

IC-205AT

120V Line Voltage

5" IC Type Housing For Incandescent

Catalog #		Type
Project		Date
Prepared by		

INCANDESCENT



DESCRIPTION

The IC-205AT is a 5" aperture housing for PAR20 and PAR30 incandescent lamps.

APPLICATION

The IC-205AT is designed for insulated ceilings and can be in direct contact with insulation material. The IC-205AT offers a wide choice of trim types including reflector, lensed and wall wash trims. This AIR-TIGHT housing design prevents airflow through the ceiling, helping save on heating and cooling costs.

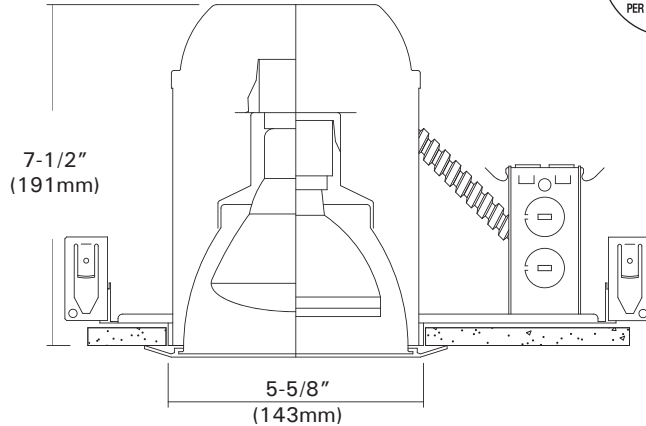

DESIGN FEATURES

◦ Housing

- Single wall aluminum housing.
- 7-1/2" height allows use in 2"X8" joist construction.
- Housing adjusts for ceilings up to 1-3/8" thick.

◦ Junction Box

- Listed for through branch circuit wiring. (Max. 8 No 12 AWG 90°C branch circuit conductors. (4 in, 4 out)
- (5) 1/2" knockouts with true pry-out slots and (4) knockouts with Romex cable clamp.
- Ground wire provided on J-box.

◦ Mounting Frame

- Galvanized steel construction.
- 10-3/8"L x 7-1/16"W

◦ Bar Hangers

- Maximum extension of 24" allows for extra distance between joists.
- Housing can be positioned at any point within 24" joist span.
- Score lines allow "toolless" shortening for 12" joists. Bar hangers may be repositioned 90 degrees.
- Integral T-bar clips snaps onto T-bars and no additional clips are required.

◦ Just-A-Nail

- Pre-installed nail bars with vertical slots are used to evenly align the bars horizontally after nailing halfway into wood joists.

◦ Socket

- Medium base porcelain with nickel-plated copper screw shell.
- Snaps into trim for consistent lamp positioning.

◦ Lamp

- Lamp ratings based on trim selected - See trim page for more details.

◦ Thermal Protector

- Self-resetting thermal protector in the housing deactivates fixture if overheating occurs due to improper lamping or insulation.

* Listing

- UL, c-UL listed for damp location.
- UL, c-UL listed for feed through.

Ceiling Cut-out : 5-3/4"
Lamp, Max, Watt. : 75W A19 / R30 / PAR30

• Just-A-Nail

Adjustable nail hanger bar for easy alignment.

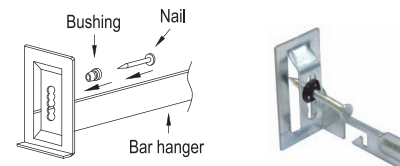

JUST-A-NAIL

• Optional "Quick Connect" Push-in wire connectors.

- Three "Quick Connectors"
- Pre-installed push-in wire connectors for fast and easy wiring.

• Compliance

- Washington State Energy Code.
- New York State Energy Conservation Construction Code.
- Certified AIR-TIGHT Under ASTM E283.

Trims

5" Incandescent Trims For

DL-205, DL-205R, IC-205AT, IC-205RAT

Catalog #		Type
Project		Date
Prepared by		

INCANDESCENT

TM-55

Open Trim
PAR30/R30-75W
 White Metal Trim Ring
 O.D : 7-1/4"



TM-55B

Metal Baffle
PAR30/R30-75W
 White Plastic Trim Ring
 O.D : 6-11/16"



TM-55R

Specular Reflector
PAR30/R30-75W
 White Plastic Trim Ring
 O.D : 6-11/16"



TM-58

Adjustable Gimbal Ring
NON-IC : PAR30/R30-75W
IC : PAR30-50W
 White Metal Trim Ring
 O.D : 6-1/2"



TM-95R

Full Cone Reflector
NON-IC : PAR30/R30/A19-75W
IC : PAR30/R30-75W or A19-40W
 White Plastic Trim Ring
 O.D : 6-11/16"



TM-115

Reflector w/ Baffle
NON-IC : PAR30/R30/A19-75W
IC : PAR30/R30-75W or A19-40W
 White Plastic Trim Ring
 O.D : 6-11/16"

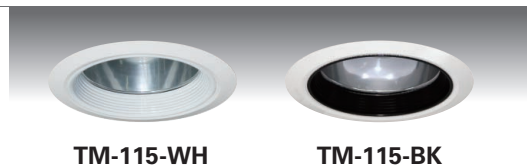

TM-850E

Eyeball
TM-850E : PAR30S-75W
TM-853E : PAR30L/BR30-75W
 White Metal Trim Ring
 O.D : 6-1/2"

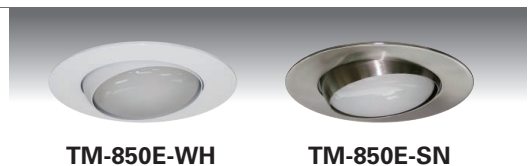

TM-855E

Eyeball
PAR20/R20-75W
 White Metal Trim Ring
 O.D : 6-1/2"

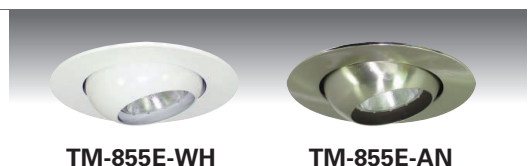

Trims

5" Incandescent Trims For

DL-205, DL-205R, IC-205AT, IC-205RAT

Catalog #		Type
Project		Date
Prepared by		

INCANDESCENT

TM-56 Shower Round Opal Lens
NON-IC : A19-75W
IC : A19-40W
 White Plastic Trim Ring
 O.D : 6-1/2"

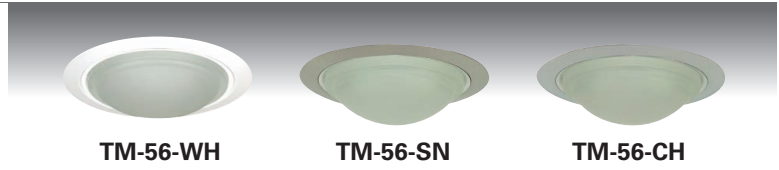

TM-57-CT Frosted Lens w/ Clear Center
NON-IC : A19 - 75W
IC : A19 - 40W
 White Metal Trim Ring
 O.D : 6-1/2"

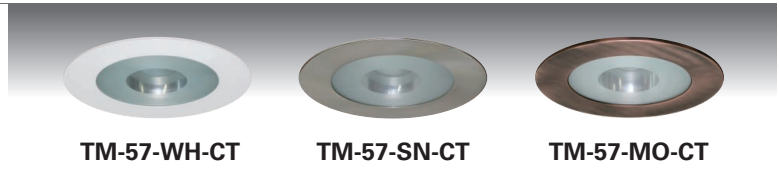

TM-57-FR Fresnel Lens w/ Reflector
NON-IC : A19 - 75W
IC : A19 - 40W
 White Metal Trim Ring
 O.D : 6-1/2"



TM-57-DO Drop Opal Lens w/ Reflector
NON-IC : A19 - 75W
IC : A19 - 40W
 White Metal Trim Ring
 O.D : 6-1/2"



TM-57-AL Albalite Lens with Reflector
NON-IC : A19 - 75W
IC : A19 - 40W
 White Metal Trim Ring
 O.D : 6-1/2"

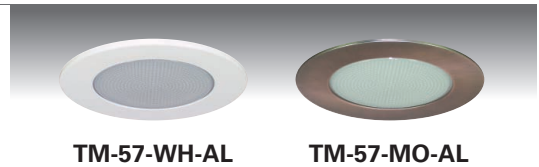

TM-58B Baffle w/ Regressed Gimbal Ring
NON-IC : PAR30/R30-75W
IC : PAR30-50W
 White Plastic Trim Ring
 O.D : 6-11/16"



TM-501 Baffle w/ Adjustable Spot
PAR16-60W
 White Plastic Trim Ring
 O.D : 6-11/16"



TM-508 Baffle w/ Adjustable Gimbal
PAR20-50W
 White Plastic Trim Ring
 O.D : 6-11/16"



Trims

5" Incandescent Trims For

DL-205, DL-205R, IC-205AT, IC-205RAT

Catalog #		Type
Project		Date
Prepared by		

INCANDESCENT

TM-255B Decorative Frosted Glass w/ Baffle
PAR30/R30-75W
 Die-Cast Construction
 O.D : 6-11/16"



TM-255B-WH

TM-255B-BK

TM-255B-BK-SN

TM-255R Decorative Frosted Glass w/ Reflector
PAR30/R30-75W
 Die-Cast Construction
 O.D : 6-11/16"



TM-255R-WH

TM-255R-CL-BK

TM-255R-BK-SN

ORDERING INFORMATION

Choose the catalog / finish codes that best suit your needs and enter it on the appropriate line.

TRIM MODEL	REFLECTOR	BAFFLE	METAL RING
	CL :Clear	WH :White	WH :White
	WH :White	BK :Black	BK :Black
	GD :Gold	SN :Satin Nickel	SN :Satin Nickel
	MA :Matte Platinum	AN :Antique Nickel	AN :Antique Nickel
	CP :Champagne	AC :Antique Copper	AC :Antique Copper
	PR :Pewter	MO :Mocha	MO :Mocha
	HC :Haze Clear	CA :Cappuccino	CA :Cappuccino
		CH :Chrome	CH :Chrome
		UN :Natural Steel	UN :Natural Steel
		PB :Polished Brass	PB :Polished Brass

Examples:

- TM-58-PB = Polished Brass Trim Ring w/ Gimbal Ring
- TM-850E-AC = Antique Copper Trim Ring w/ Eyeball
- TM-56-UN = Opal Lens w/ Unfinished Metal Ring